

Knürr Technical Furniture

Your Workplace Specialists

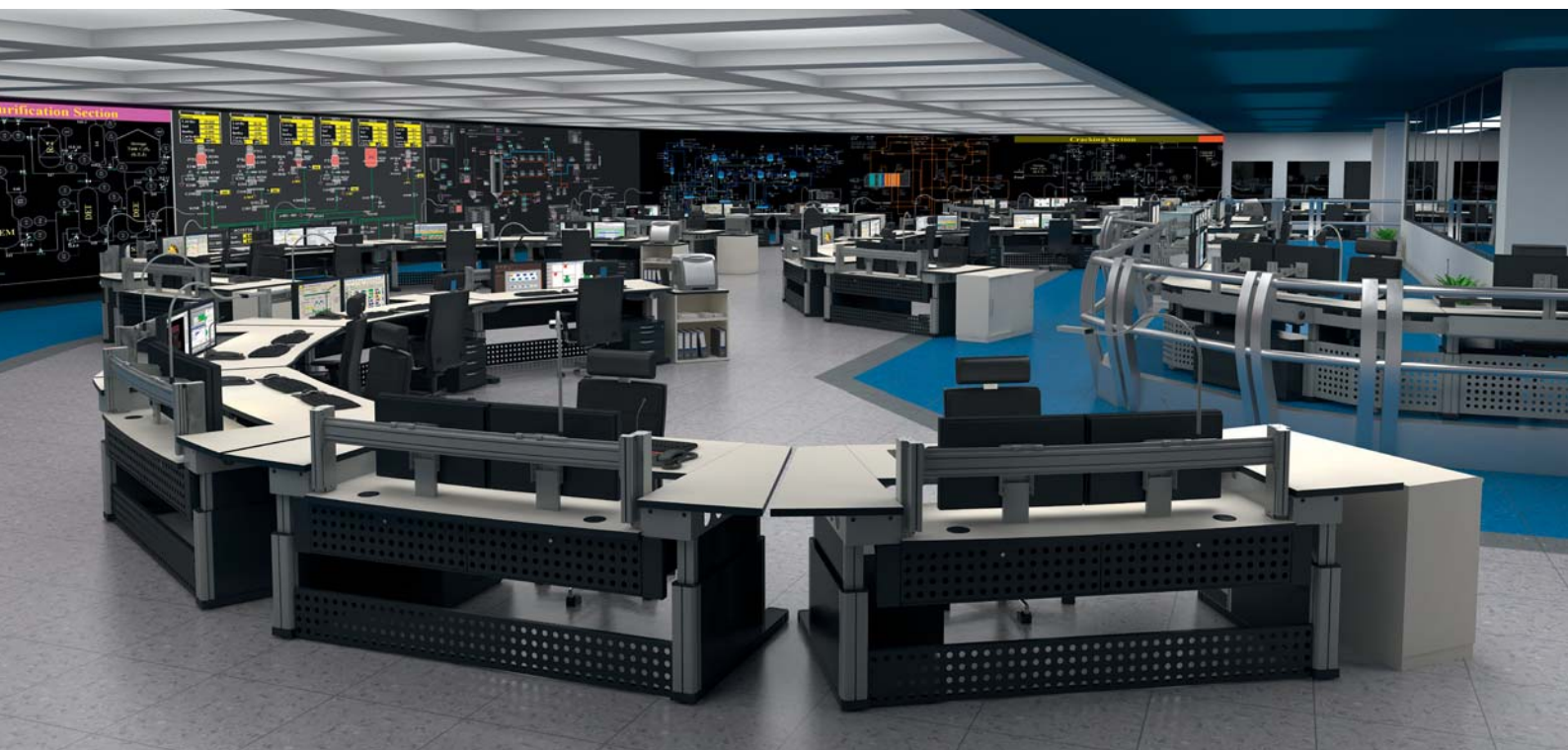

Tradition Innovation Future

■ About Us	4
• Logistics & Production	6
■ Product Portfolio	8
■ Industry Skills	12
• Industrial	14
• Traffic.....	16
• Security	18
• Electronics.....	20
• Diagnostics.....	22
■ Solutions & Integration - Workstations	24
■ Space Concept & Design	28



Welcome to *Knürr Technical Furniture*

For over 30 years, Knürr has been recognized as an innovative, full service company with the expertise to deliver maximum functionality and user comfort to our customers. We are proud to be an integral part of Vertiv's global Technology Group.

Knürr's team of highly qualified and veteran professionals – from distribution through in-house technicians, certified design engineers, logistics specialists to service technicians – all work together to deliver solutions that exceed the demands of your planned project. We are leaders in creating workplaces which are ergonomi-

cally designed to your specific tasks and requirements. Our experienced and certified staff understands all aspects of your desired system architecture, ergonomics and modern room layout planning, as well as the relevant EC machinery and facility standards.

Knürr Technical Furniture – Man and Technology United in Harmony

We would like an opportunity to introduce you to the quality of Knürr's products. Interested Parties can reach us at:

Hotline: +49 8723 28 0

Email: furniture.knuerr@vertivco.com

Consulting Service on Site
Engineering & Project Management
Logistics & Production
Assembly on Site
After-sales & Services

YOUR WORKPLACE SPECIALISTS

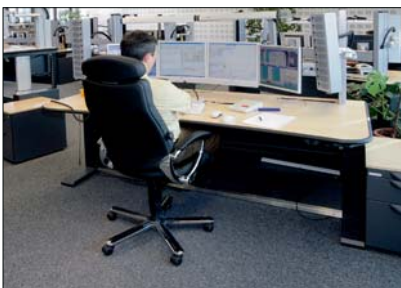

About Us:

Knürr is a recognized global leader for holistic workspace concepts and Mobile Equipment Carriers, with a unique ability to integrate customer's complex technology in systems that achieve the highest level of functionality.

Knürr Technical Furniture's product philosophy:

- **Safe investment** due to product durability and on-site upgrading.
- **Reliable** due to proven designs and environmentally friendly materials.
- **Innovative** ergonomic designs resulting from occupational-medical research.

- **Customized** solutions due to analysis of process cycles and space conditions.
- **Future-proof** due to modular design and high durability of materials used.
- **Upgrading** to the latest product introductions and newest technologies available at any time thanks to modular construction.
- **Holistic approach** of control room design through partnerships with leading suppliers in a variety of complementary fields.





Made in Germany • Trustworthy • Customized Workplace Systems • Efficient • 12 Sales Engineers • 6 Product Managers and Developer • 17 Applications Engineers/Customer Consultants • > 100 employees at Knürr Technical Furniture • Integrated into the Vertiv Group with more than 20,000 Employees • Personal Contact • Modular and Future-proof • All from a single source • Newest Machinery • More than 30 Years of Industry Experience • 17 Design Engineers • 27 in Project Execution • Based in Bavaria, Germany • On Time – Straightforward and Easy Business Processing • Sound Knowledge of Processing of complex OEM and Series Production • Industry-Specific Workshops

Globally Available in Your Language – Contact Us!



Headquarters: Germany - Arnstorf / **Branch Offices:** Munich and Neuss

Austria / Belgium / Bulgaria / China / Croatia / Czech Republic / Denmark / Finland / France / Greece / Hungary / India / Israel / Italy / Japan / Kosovo / Malta / Norway / Netherlands / Poland / Portugal / Russia / Serbia / Singapore / Slovakia / Slovenia / South Africa / Spain / Sweden / Switzerland / Turkey / Ukraine / United Arab Emirates / United Kingdom GB / United States of America

Lean

Kanban & Pull

5S + 1

Value Stream Mapping

Complexity Reduction

LOGISTICS & PRODUCTION

EFFICIENCY



Highest Efficiency through Newest Methods, Procedures and Equipment

Knürr products are available in large or small quantities, but always with the same degree of quality, flexibility and cost savings.

Our Strengths:

- Production of your individual products using ultra-modern industrial production methods.
- Experienced Employees in all phases of production.
- Longstanding cooperation with efficient suppliers.

Our state-of-the-art logistics system guarantees a secure and on-time delivery, including assembly on site:

- Broad packaging competence for transport by road, air and sea.
- Client-specific shipping documents and customs documents.
- Reliable logistics partner for punctual delivery world wide.
- Assembly teams for the local assembly of our desk systems world wide.

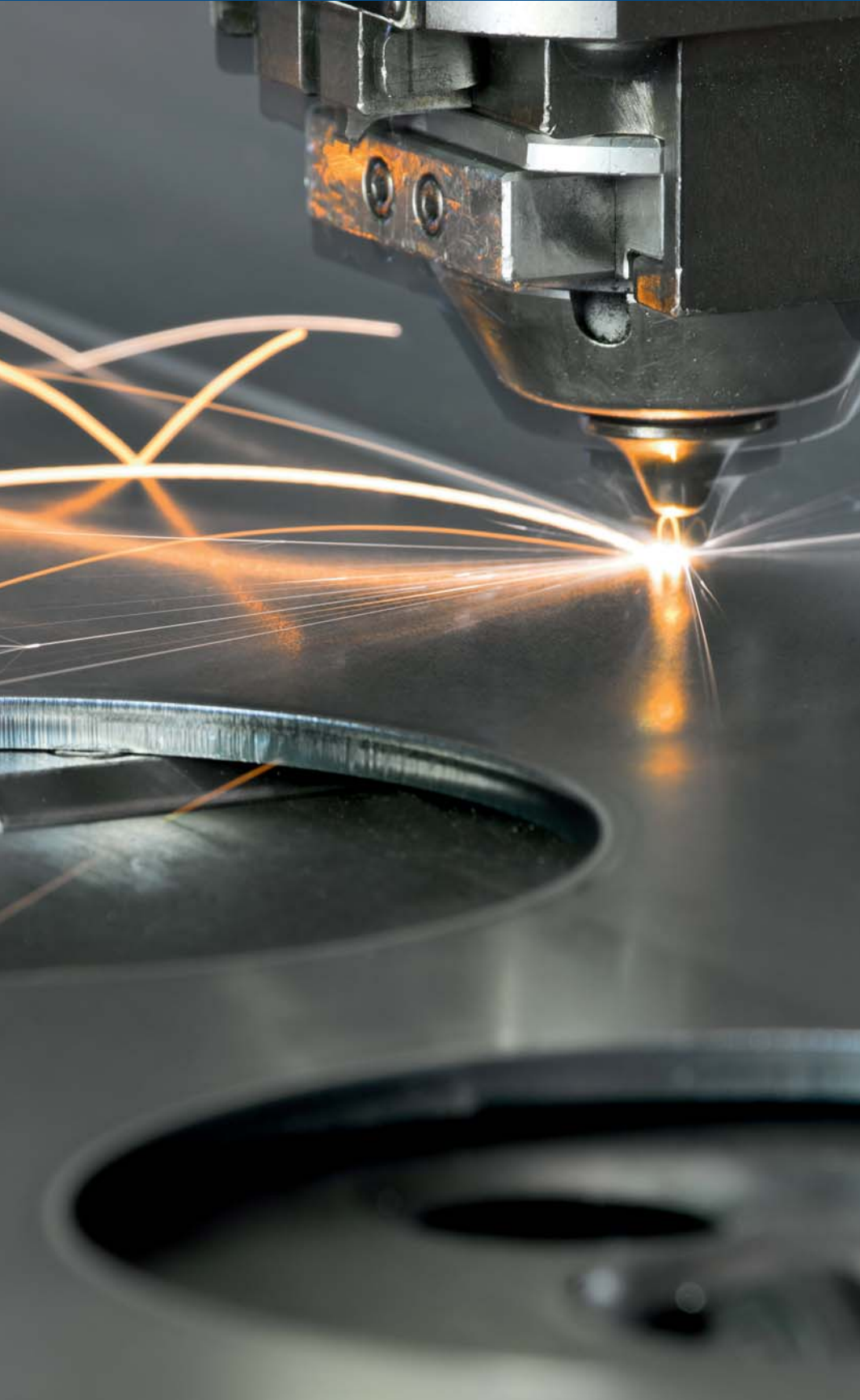

6,500 m² Assembly Floor and Storage • Precise Laser Processing • Modern Sheet Metal Forming • Powder-Coated Metal and Aluminum Parts • Wood Machining with Postforming Technology • Innovative Materials • Adhesion Technology for Glass • Foam Gusseting • 3 logistics specialists for preparation of customs documents • 40 Assembly- and Packing Staff • 400m² factory acceptance test area

technical-furniture.com

Control Rooms/Operation Centers
Mobile Equipment Carriers
Accessories
Measuring, Testing, and
Laboratory Technology

PRODUCT PORTFOLIO



■ Control Rooms / Operation Centers:

Our ergonomically designed products are engineered to meet a demanding 24 hour use, and used in control rooms and operation centers worldwide.



■ Measurement Testing- and Laboratory Technology:

As specialists in workstation design, Knürr products are used in the automotive, medical, and electronics industries, as well as research and development

laboratories worldwide. Our diversified offerings of fixed and mobile workplace solutions provides a variety of possibilities to position your electronic equipment where it is needed.

■ Suitable Accessories:

Our accessories range from office chairs to optimized lighting solutions designed to improve working conditions in a variety of work environments.

Feel free to contact us, our staff will be happy to help you.



ation Section



■ CONTROL ROOMS/OPERATION CENTERS



Synergy®

The product family for a uniform and modern outfit

- Monitoring Centers and Control Centers
- Control room and measuring station
- Security and Emergency Centers



ErgoCon®

Height adjustable Console for

- Emergency Center
- Coordination- and Situation Rooms



Dacobas®

Modular workstation systems for:

- Monitoring Centers and Control Centers
- Control room and measuring station
- Security and Emergency Centers



Large Screen technology

and KVM solutions for efficient process management:

- Monitor stacks
- KVM (Keyboard – Video – Mouse)
- Video Management
- Imaging

■ ACCESSORIES



Chairs

- 24/7 chairs
- Office and conference chairs
- ESD chairs



Ergonomic Flat Screen Supports

- For universal use with flat screen monitors



Contract Furnishing

- Cabinets
- Mobile Container
- Integrated furniture solutions
- Acoustic elements and partition walls



Workstation lighting

- Overhead lighting
- Substructure lighting
- Retractable lamps

■ MEASURING TESTING- AND LABORATORY TECHNOLOGY



Electronic Engineering Workstations

- Developer workstations
- Service Workstations
- Laboratory Workstations
- Assembly Workstations



Elicon®

Modular Workstation
System for:

- Technology and Office
- Control- and measuring station
- Control room and measuring station



Dacorack 19"

Flexible 19" storage for
KVM- and IT equipment:

- Monitoring Centers and Control Centers
- Control- and measuring station
- Measuring and Testing workstations
- Laboratories

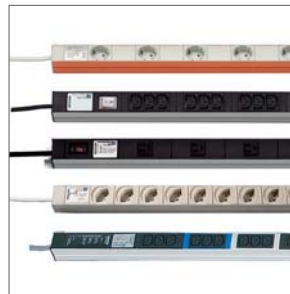

Power Distribution / Socket Strips

- 16A single phase or triple phase
- GST18 connection system
- Compact 19"
- Protector (earth-leakage trip, overload protection)
- Safety (Electrical surge, line breaker)

■ DIAGNOSIS



Mobile Equipment Carrier

- Automotive
- Medical Environment
- Industry
- Production and Assembly
- Research & Development



EliMobil®

- Space-saving
- Compact
- Attractive



DacoMobile®

- Load rating up to 2100N
- Ergonomically optimized adjustments



Standard/ Customized/OEM

- Modular standard solutions
- Customer-specific solutions



SynergyCart®

- Distinctive Design
- Accessibility at its best



MetraMobil®

- High variability
- Well thought-out solutions
- ESD safety

Reference Customers:

Air France

Airbus

Emerson Process Management

Ineos

Yokogawa

INDUSTRY SKILLS



High-level Competence, long-time experience and industry specific know-how

Thanks to the knowledge of our engineers and certified workstation experts, Knürr is able to take all aspects of the desired system architecture, ergonomics, modern space planning, and guidelines for machinery and equipment use into consideration when designing new products.

We are not only concentrating on one individual industry. We gained a lot of experience while working for a long time in diverse areas and we have the necessary industry specific know-how. Knürr's

design expertise covers a wide variety of industries while still providing industry specific know-how our customers require.

Our expertise includes:

- Control room consoles and control centers designed for application in industrial environments.
- Control centers for traffic surveillance.
- Control centers designed for application in security, coordination and security.
- Measurement Testing Technology and Laboratory Technology.
- Mobile Equipment Carriers.



INDUSTRIAL



TRAFFIC



SECURITY

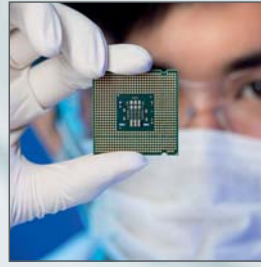

ELECTRONICS



DIAGNOSTICS



Reference Customers:

- ABB
- Siemens
- Bayer
- ZF
- Bosch
- BASF

**PROCESS AUTOMATION/CONTROL
ROOM AND MEASURING STATION**
INDUSTRIAL

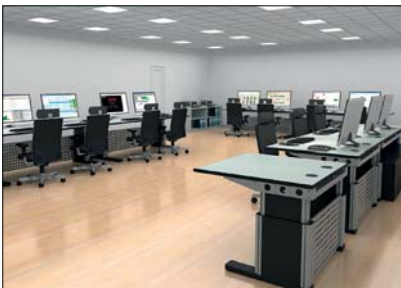

**Control Room Consoles and Control Centers
for application in industrial environments**

While similar, technical requirements for various process monitoring solutions require specific professional knowledge.

Today's 24 hour use places high demands on the operator, the technical equipment and of course on the furniture.

With our products and solutions Knürr has created workstations and control rooms which are perfectly adjusted to any task or operation. Our products are right at home in comfortable, rough or dirty environments. Knürr Technical Furniture's solutions are adjustable to meet any require-

ment, and have proven themselves around the world. Knürr's most important feature is our ability to meet your demands. A key benefit to Knürr's design is our ability to carry out retrofits or reconstructions even during live operation to reduce or even eliminate downtime.

We incorporate and integrate:

- **General and industry-specific hardware**
- **Indicating modules**
- **Alarm elements**
- **Wiring**
- **Lighting**
- **Acoustic modules**

SOLUTIONS FOR:

Chemical industry • Power Generation • Network Operators • Oil and Gas • Automotive Manufacturing • Pharmaceutical • Water and Sewage • Metallurgy and Mining



Emergency - stop
and Auxiliary panel

▼ Test stand comprised of Workstation-rack combination – Product Dacobas/Dacobas 19"-rack

▲ Measuring station with Sit-Stand Operator positions – Product ErgoCon



Electronics rack fully
integrated into work-
station

Reference Customers:

Port of Hamburg
New Doha International Airport
German Railway
MIVB Brussels Public Transport
Eurocontrol
Hongkong Airport

COORDINATION AND DISPOSITION TRAFFIC



Control Centers for Traffic Surveillance

With its planning and execution technologies, Knürr Technical Furniture develops furniture concepts for 24/7 use in control rooms as well as operation centers and control centers.

An ergonomic workstation enables people charged with extremely demanding tasks to achieve a high level of concentration and efficiency.

- **Perspective** - technical integration and ergonomically optimized placement of monitors, projectors and additional information systems.
- **Connected** - rooms adjacent to the workplace environment stay connected via flexible connection of individual modules.
- **Intelligent** - easy integration of 19" elements, ventilation systems from other vendors.
- **Customized** - an easy and comprehensive cable management system.
- **Calm** - a pleasant workstation sound level for your workplace.
- **Illuminated** - light and brightness at the right spots at your workstation.

SOLUTIONS FOR:

Road • Air • Rail • Water

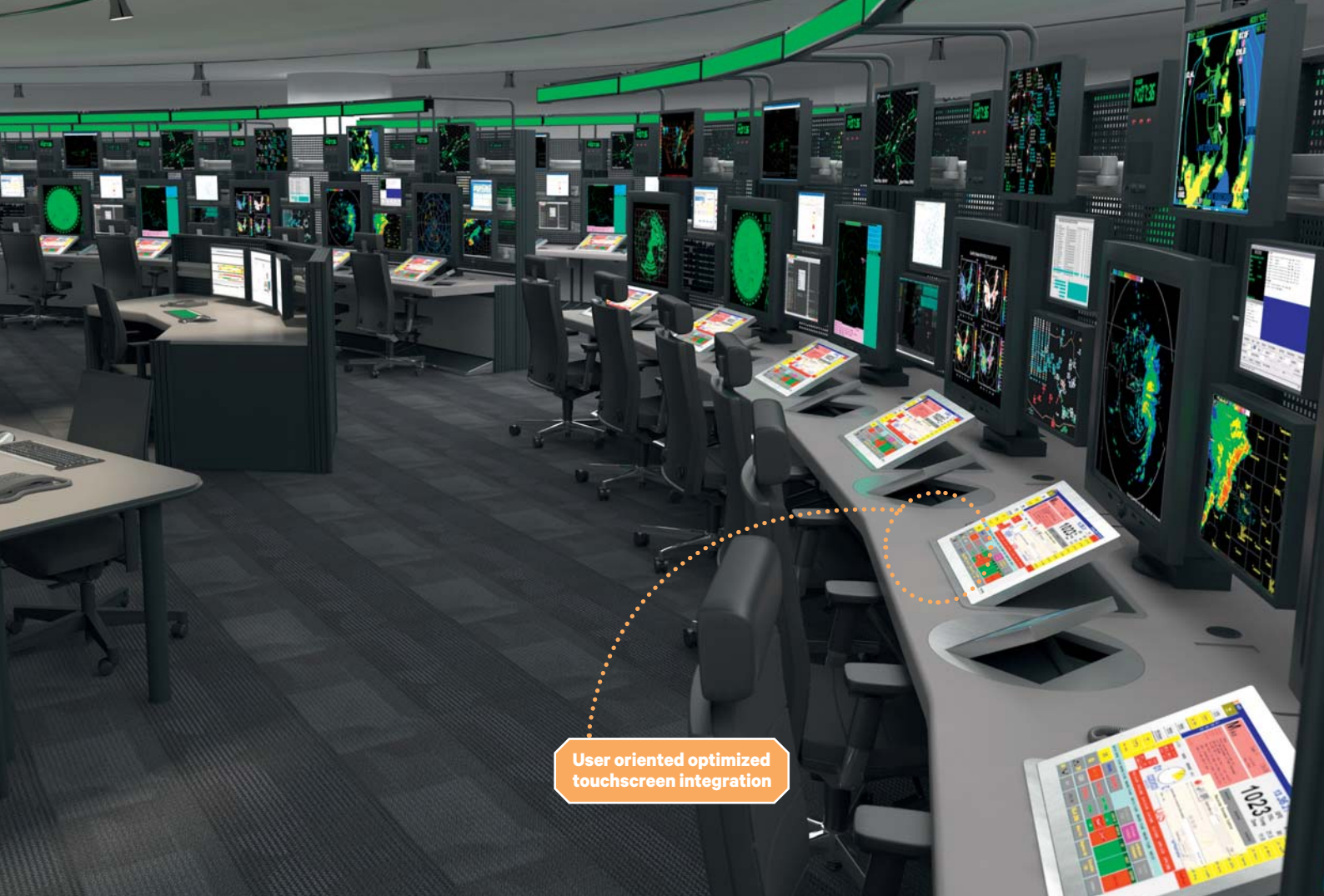

User oriented optimized
touchscreen integration

▼ Railroad consoles - maximum of technology
in a confined space – Product ErgoCon

▲ Air traffic Controller Workstation –
Product Dacobas



Reference Customers:

- Royal Air Force
- German Police
- Ministry of Interior - Saudi Arabia
- Sellafield Power Plant Security
- Serco Defense
- Plant Fire Brigade Volkswagen

MUNICIPALITIES AND ORGANIZATIONS WITH SECURITY TASKS

SECURITY



Platform



Tilting



Modular front panel

Control Centers for Security, Coordination and Surveillance

Due to our extensive experience in ergonomically equipping workstations, our experts at Knürr Technical Furniture develop perfectly adjusted workstations for: fire departments, emergency services, disaster prevention, civil protection, police departments and the private security sector.

Following the motto "Designed for Humans", our Emergency Centers are designed for a 24 hour workplace, and help to secure a flawless response process.

Knürr's design considerations incorporate:

- **Your control station** - customized to your needs, whether it's an operation station, Scheduling or Situation Room.
- **Visualizing** - large screens, smartboards, whiteboards, sliding boards.
- **Wiring** - no more cable clutter which disrupts a smooth process.
- **Lighting** - fatigue-proof application due to glare-free, retracted, dimmable LED overhead lights.
- **Acoustic** - for room environments which enable a security-related operating.

SOLUTIONS FOR:

Police-Fire-Rescue Center • Security Centers/ Emergency and Service Control Centers • Security Guards/ Gates • Integrated Control Stations • Command and Situation Centers



Our customers set the Standard. Our answers are Quality, Flexibility, Speed and perfect Service

▼ Police Workstation Dresden – Product ErgoCon

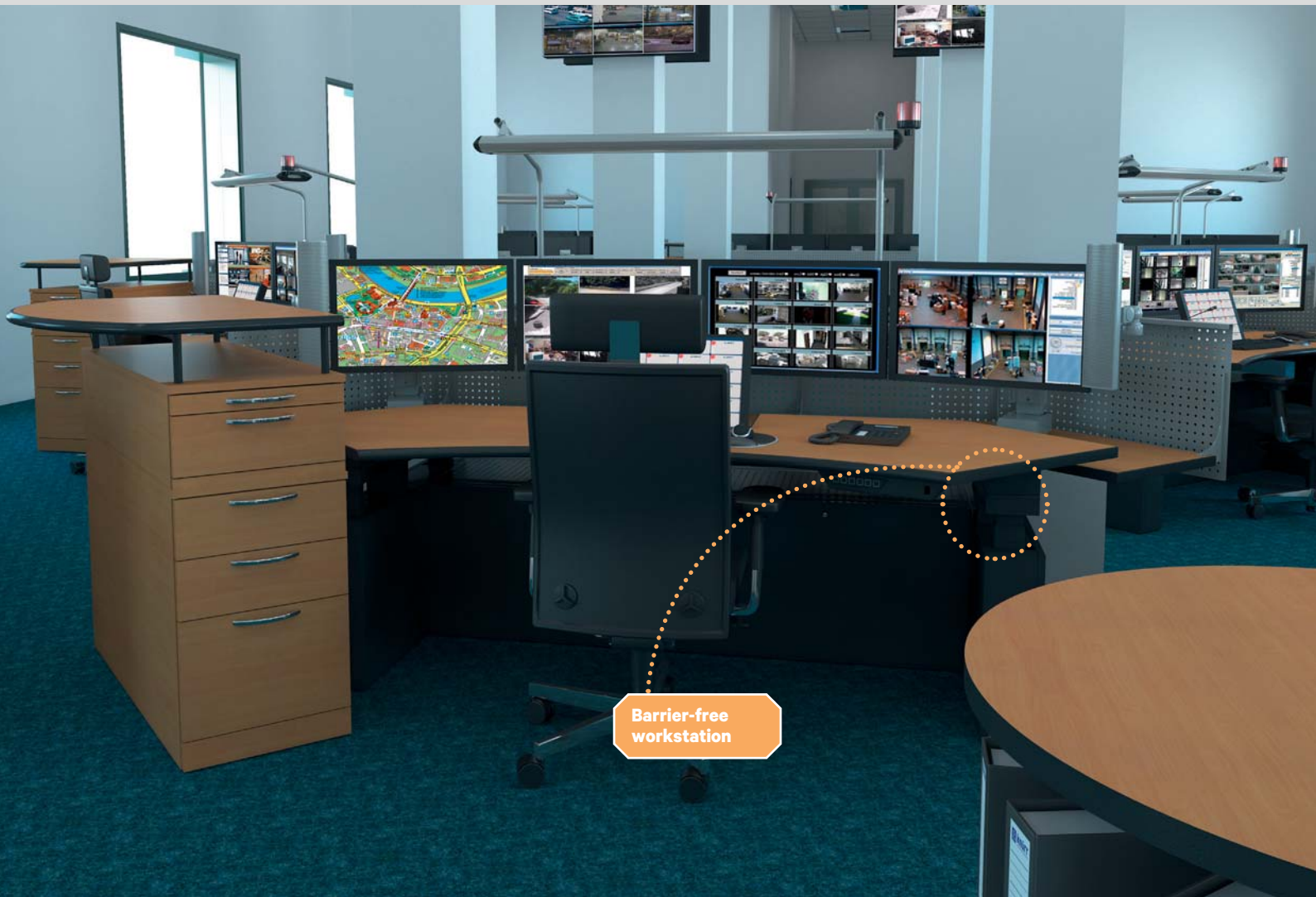

Barrier-free workstation

Reference Customers:

- Thales
- Airbus
- Intel
- Infinion
- Apple
- Siemens
- Texas Instruments

**MEASUREMENT TESTING TECHNOLOGY
AND LABORATORY TECHNOLOGY**
ELECTRONICS



Elicon®



Elicon®



Dacobas®

Modular Workstations for Electronic Engineers

Knürr's Workstation for Electronic Engineers is a modular desk system designed to grow with your changing requirements and is consistently exceeding ergonomic guidelines.

This high level of flexibility in desk superstructures and Knürr's diverse desk systems permit individual adjustments to various metrological requirements.

According to customer-specific instructions, we design and produce:

- **Test and Services Workstations**
- **Assembly and Production Workstations**
- **Training and Instruction Workplaces**
- **Workstations for Research & Testing**

Our ESD-workstations reliably meet the rigorous requirements and standards for working with electrostatically sensitive components:

- **Insulation according to VDE0100, §24 as well as DIN 57 680-2**
- **Protection of electronic components against electrostatic discharge EN 61340**

SOLUTIONS FOR:

Automotive Industry • Education • Electrical Engineering • ESD areas and protection of electronic components • Storage for sensitive components • Measuring and calibration • Quality control • Research & Development

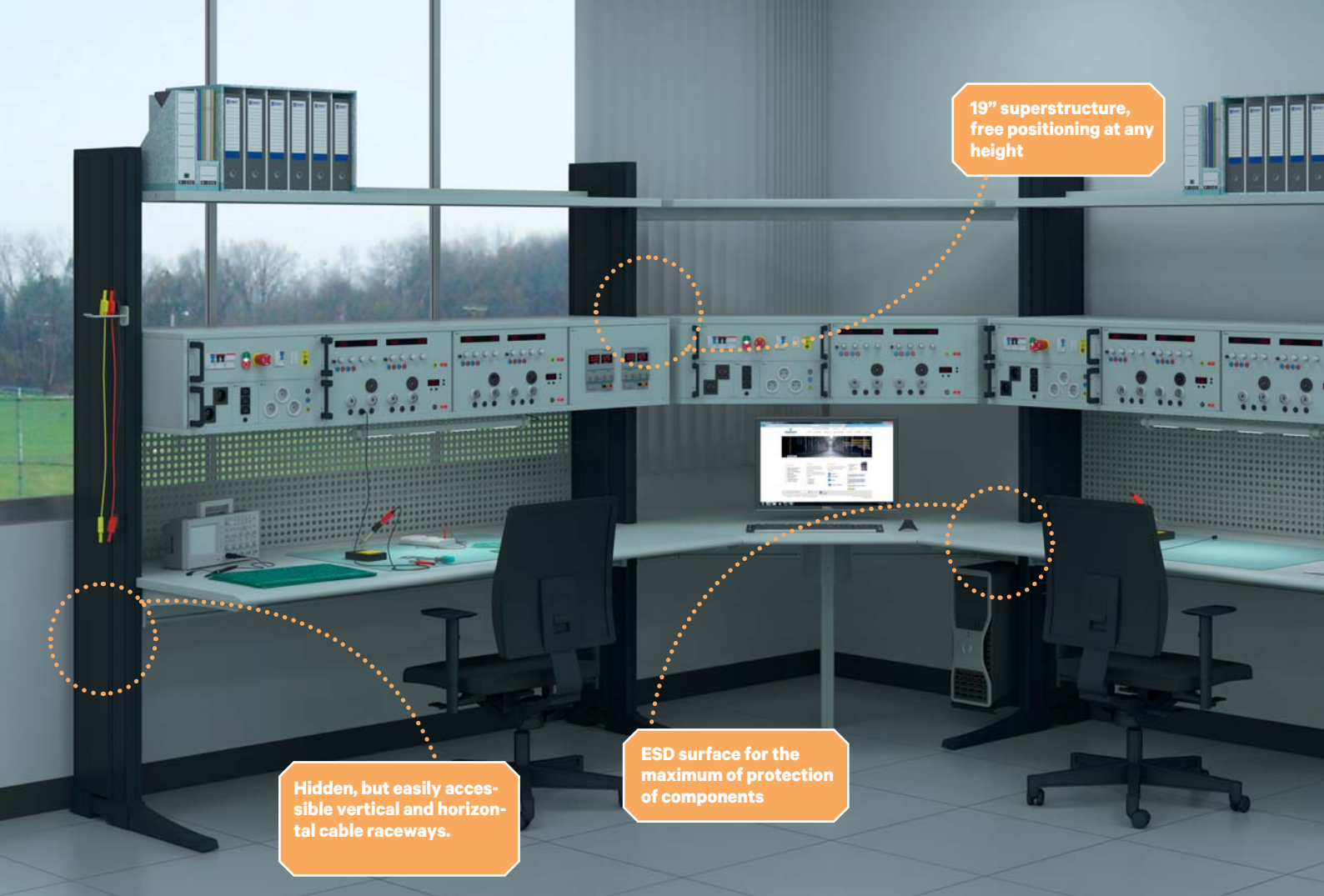

19" superstructure, free positioning at any height

Hidden, but easily accessible vertical and horizontal cable raceways.

ESD surface for the maximum of protection of components

▼ Training workstation with immersible instrumentation – Product Elicon

▲ Measuring Lab – Product Elicon



Immersible instrumentation - electrically actuated

Integration of measuring instruments and power supplies

Reference Customers:

- Volkswagen
- GE Medical
- ACD-Gruppe
- Siemens
- BMW
- Natus

**AUTOMOTIVE INDUSTRY /
MEDICAL ENGINEERING / LOGISTICS**

DIAGNOSTICS



EliMobil®



ServoMobil®



DacoMobile®

Mobile Equipment Carriers

New workstation concepts and services are aiming to follow the motto “flexibility due to mobility”. Nowhere more clearly as with our Mobile Equipment Carriers.

Whether it be in health care applications, workshop area, electronics labs or in warehouses, Knürr’s extensive standard range of mobile and ergonomically built equipment carriers provides diverse solutions for the safe and secure mobility of valuable equipment.

Our modular designs enable versatile cart configurations:

- **Robust Transport Trolleys**
- **Measurements and Diagnostics Carts**
- **Cart Systems for ESD environments**

A large range of accessories supplements our mobile equipment carriers. These include: Flat screen holders, isolating transformers and leakage detectors, cable routing elements, functional rails, various adapters and other accessories for the medical sector.

SOLUTIONS FOR:

**Medical Technology • Automotive Industry • Logistics •
Electronics Industry • Security • Education • ESD areas**



▼ Lockable diagnosis cart – OEM product solution

▲ Endoscopy cart with integrated isolating transformer – OEM product solution



Workplace Lighting
Wiring
Customer-specific Assembly
Cooling Systems
Ergonomics

SOLUTIONS AND INTEGRATION



Cable Management



Integration of Technology

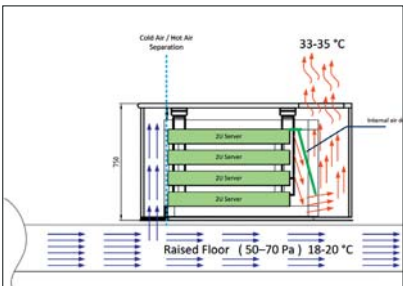

Cooling System

Your Workplace Experts

Right from the start, one of our experienced Project Managers will support you and advise you with their extensive professional knowledge. This knowledge was collected during decades of client projects in multiple industries as well as selective training and further education.

Depending on your application, our Project Manager will assemble the experts to meet your requirements.

Our specialist teams care for the following areas:

- **Cooling:** calculation and conceptual design for an optimized operation.
 - **Material Selection:** use of the most suitable materials, colors and surfaces to fulfill fire protection regulations and noise reduction requirements.
 - **Ergonomics:** individually adjustable workstations for a fatigue-proof and healthy working environment.
 - **Lighting:** perfect illumination of workplaces to relieve the eyes and maintain concentration.
 - **Project and Product Documentation:** from the assembly instruction, to the conformity certificate, to the extensive customer-specific technical paper.
 - **Assembly:** an initial fitting, on site installation, and initial operation are all part of our service.
- **Customization:** configuration of existing product modules or customized solutions.
 - **Cable Management:** pre-cabing of power, audio/video and network connections.

Integration of a communication and control system



Easy to equip technical pedestal

✓ Air traffic controller workstation – rear view/Technical pedestal – Product Solution

▲ Airline Emergency Position – Product Dacobas

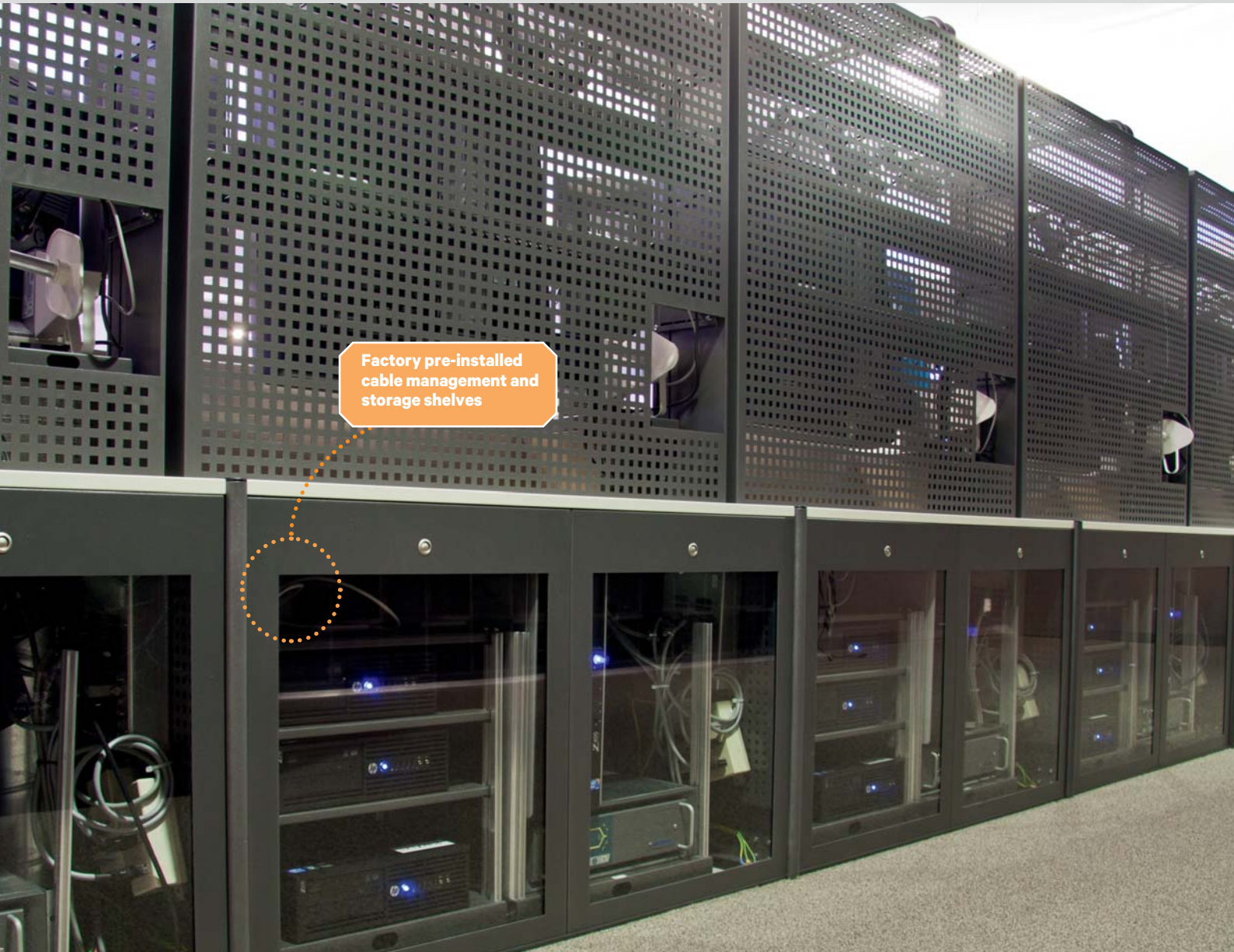

Factory pre-installed cable management and storage shelves

Project Documentation
Assembly Instructions
KVM/A Integration
Display Technology
Consulting

SOLUTIONS & INTEGRATION



Individual Project Solutions – No Problem!

Many application scenarios demand a project specific solution.

When planning, manufacturing, and assembling your individual requirements, Knürr takes multiple factors into account, including your personal requirements as well as legal guidelines.

Sample Considerations:

- Preparation of the requirement specifications with clear budgeting and scheduling.
- Observation of unique design specifications subject to regulations and standards.
- Technical integration.
- Detailed project documentation.
- Economical use of existing components and modules.

Industrial designers and Technicians closely cooperate at our product design department to bring form and function in line.

The resulting designs are regularly tested by means of 3D-CAD models and you are welcome to incorporate your ideas any time. Any required prototypes are manufactured by experts who translate your wishes and ideas into a real product.

After finalizing the product design, our assembly team takes over the appropriate and proper assembly, installation and initial operation on site.



✓ Combined Control room manager workstation – Conference desks

▲ Emergency Operator workstation with integrated displays

Extendible Video-conferencing system

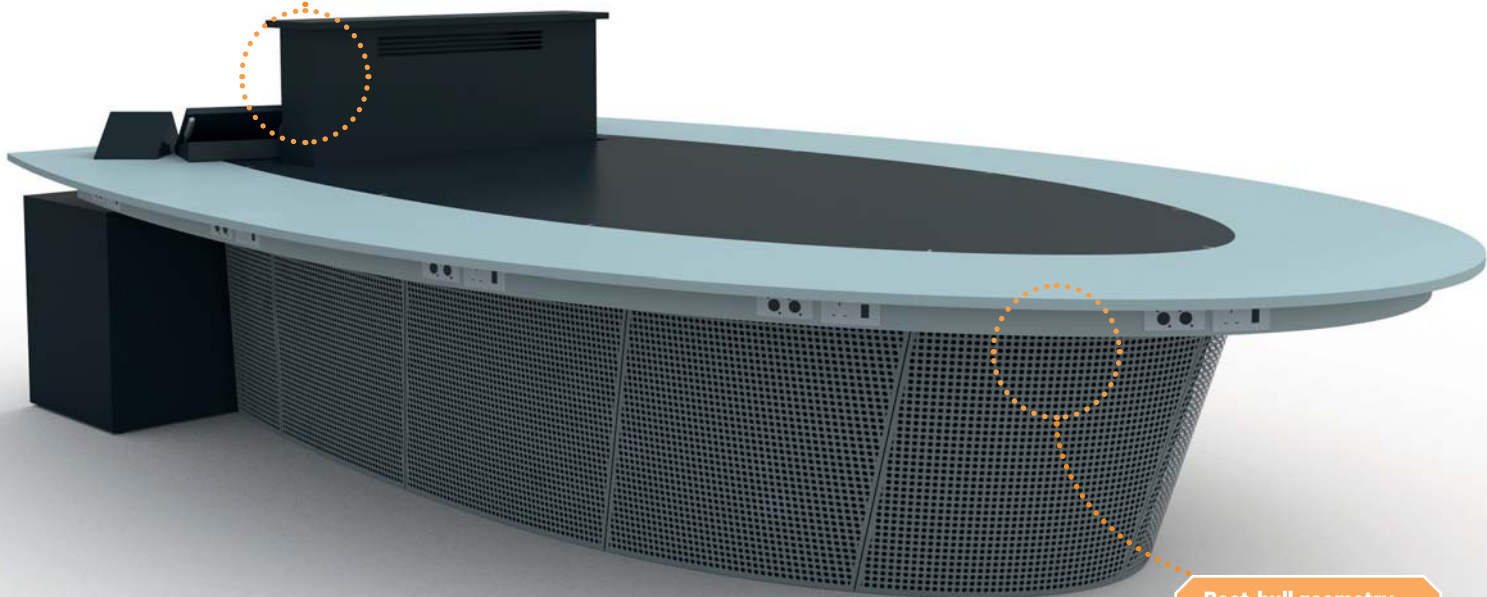
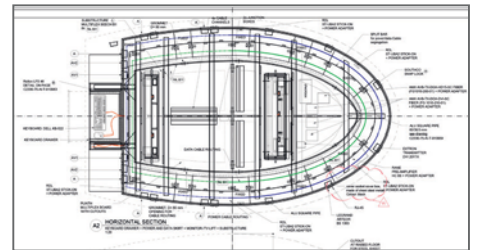

Boat-hull geometry according to architectural specification

Built-in Closets
Supplemental Furniture
Accessories
Conference Tables
Counter Units

SPACE CONCEPTS & DESIGN



Cube Enclosure



Divider



Counter Units

Ergonomics as a Productivity and Comfort Factor

In technical working areas, functionality has highest priority. Often, the importance of ergonomic designs is overlooked.

Ignoring those facts can lead to major problems: health issues and the resulting absences cause a larger loss than investing in appropriately functioning furniture. Additionally, employees at emergency and service control centers are usually working in shifts, meaning multiple employees share one workstation. This shared work environment requires that the work equipment is dynamically and flexible adjustable to the respective needs of the individual employee.

Our certified design experts for workstations provide support starting from the first concept to the finished planning.

Knürr's designs and products exceed DIN EN 50518 standards for a smooth and successful running of your control center.

- **Ergonomic Design of Control Centers (ISO 11064)**
- **Office Furniture / Office Desks (DIN EN 527)**



Acoustically effective fairings

▲ Task-oriented furnishing

▼ Holistic Emergency Center Conceptual Design

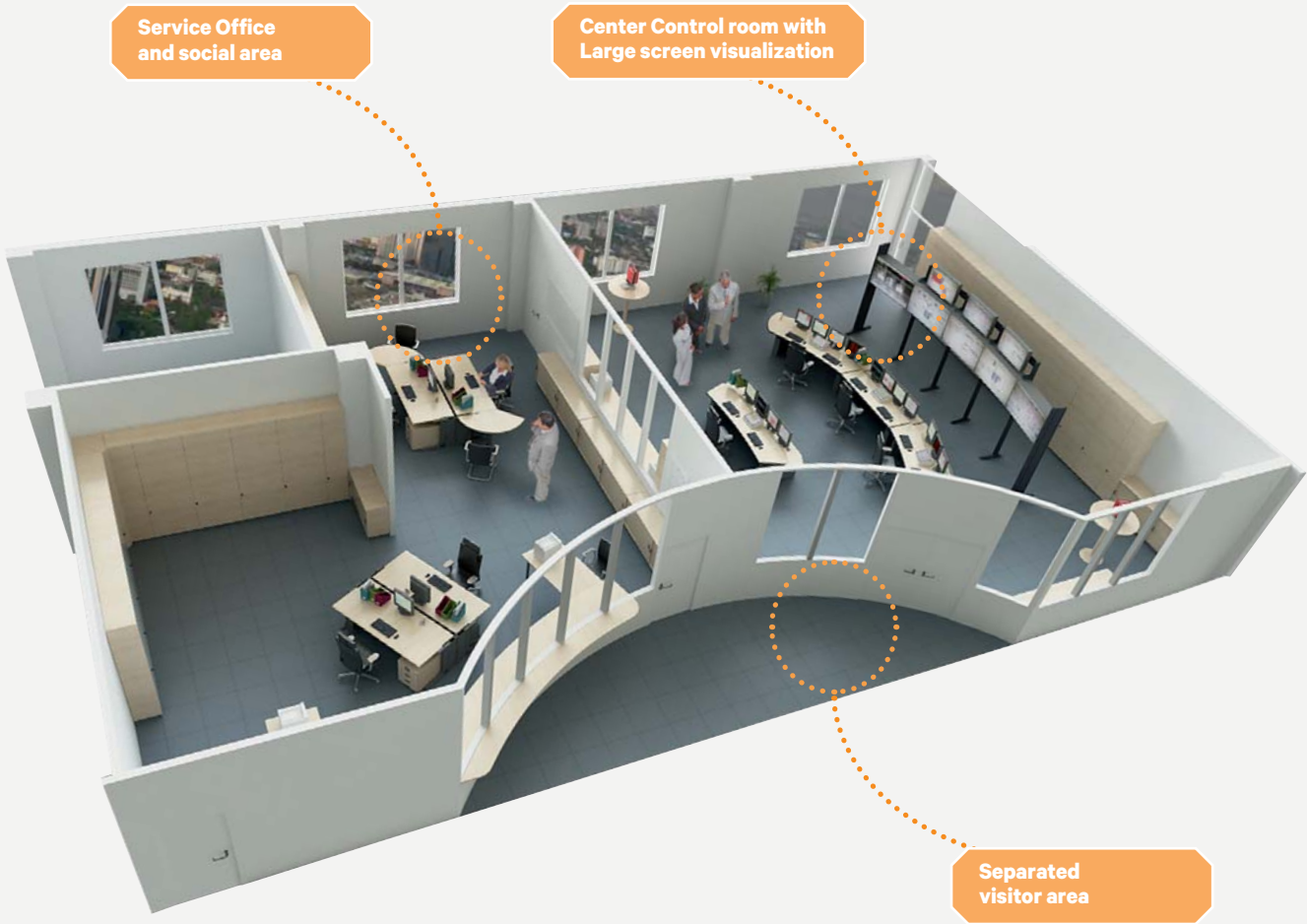

Service Office and social area

Center Control room with Large screen visualization

Separated visitor area

- Acoustics
- Ergonomics
- Room Layout Planning
- Consultancy
- Illumination
- Climate Control

SPACE CONCEPTS & COMPOSITION



Design & Function for a modern Room Layout Planning

Using the latest CAD applications, Knürr designs your product to set the pace of technology and aesthetics.

Based on your project details, we create 3D views, design studies, photo-realistic portrayals and volume models, showing each step of the design phases as close to reality as possible. This attention to realism allows You to modify your designs at any stage of your project.

1. Desk design

- Anthropometrics
- Work surfaces, work levels
- Free legroom, depth and height of legroom
- Tilting angle of displays
- Viewing angle to displays, etc.

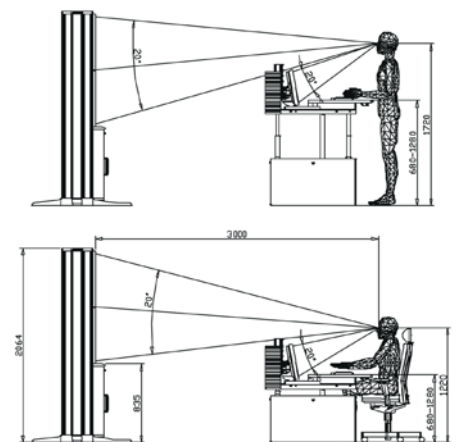



2. Space requirements and room layout

2.1 Concept

- Recording of current status
- Customer survey
- Conceptual planning
- Layout planning

2.2 Basic Design

- Design of Room layout
- Light Planning
- Ergonomic design
- Acoustics
- Color selection, color combinations

2.3 Planning of execution

- In-detail design of control room, consoles, plant equipment and facilities
- Climate Control

2.4 Construction design and Production

- Construction design of the equipment/outfit
- Installations
- Completion of interior work

3. Illumination

- Knürr offers an optimum of combinations from indirect, evenly distributed room illumination plus individual task lights.
- Avoid direct glare and reflective glare.

4. Acoustics

- According to acoustic specialists, recommended sound levels for office and control rooms is in the range of 35 – 40 dB(A) and should not exceed 55 dB (A).
- Knürr purposefully avoids noise transmission through the proper selection of materials. Measures are taken to eliminate distracting sound sources through the use of sound-absorbing surfaces with appropriate materials for floor, ceiling, walls, window-fronts, cabinets and partition walls.

5. Room climate

With testing methods upon request, our climate engineers and workspace specialists make sure that the requirements and standards concerning room temperature, humidity, and air flow speed will be met.

6. Aesthetics and Wellbeing at the workplace

Additional individual and subjective factors are taken into account with the aid of Knürr's design staff.

Get your individual consultation by calling +49 (0) 8723 28 0

Ergonomically designed products and solutions from a single source

The **Knürr Technical Furniture** manufactures and develops workstations for electronics labs and mobile equipment carriers for healthcare and automotive industries. Furthermore Knürr Technical Furniture is the specialist for height adjustable control room workstations.

Learn more about Knürr Technical Furniture products and services at **www.technical-furniture.com**

Knürr Technical Furniture is a Vertiv Co. Company

Knürr GmbH

Mariakirchener Straße 38
94424 Arnstorf
Germany

T +49 8723 28 0

F +49 8723 28 138

furniture.knuerr@vertivco.com

www.technical-furniture.com

Vertiv™

Global Headquarters
1050 Dearborn Drive
P.O. Box 29186
Columbus, OH 43229, USA

T +1 614 8880246

www.vertivco.com

While every precaution has been taken to ensure accuracy and completeness herein, Knürr Technical Furniture and Vertiv Co assumes no responsibility, and disclaims all liability, for damages resulting from use of this information or for any errors or omissions. Specifications subject to change without notice.

Knürr and the Knürr logo, are trademarks and service marks of Vertiv Co. or one of its affiliated companies. ©2016 Vertiv Co. All rights reserved.